

CUS250LD Series

Instruction Manual

BEFORE USING THE POWER SUPPLY UNIT

Be sure to read this instruction manual thoroughly before using this product. Pay attention to all cautions and warnings before using this product. Incorrect usage could lead to an electrical shock, damage to the unit or a fire hazard.

DANGER

Never use this product in locations where flammable gas or ignitable substances are present. There are risks of igniting these substances and exploding by an arcing.

WARNING

- Do not touch this product or its internal components while circuit is live, or shortly after shut down. There may be high voltage or high temperature present and you may receive an electric shock or burn.
- When this product is operating, keep your hands and face away from it as you may be injured by an unexpected situation.
- Do not make unauthorized changes to this product, otherwise you may receive an electric shock and void your warranty.
- Do not drop or insert anything into this product. It might cause a failure, fire and electric shock.
- Do not use this product under unusual condition such as emission of smoke or abnormal smell and sound etc. It might lead to fire and electric shock. In such cases, please contact us. Do not attempt repair by you, as it is dangerous for the user.
- Do not operate these products in the presence of condensation. It might lead fire or electric shock.

CAUTION

- This power supply is designed and manufactured for use within an end product such that it is accessible to SERVICE ENGINEERS only.
- Confirm connections to input/output terminals are correct as indicated in the instruction manual before switching on.
- Input voltage, Output current, Output power, ambient temperature and ambient humidity should be kept within specifications, otherwise the product will be damaged.
- Do not operate and store this product in an environment where condensation might occur. In such case, waterproof treatment is necessary.
- Do not use this product in environment with a strong electromagnetic field, corrosive gas or conductive substances.
- For applications, which require very high reliability (Nuclear related equipment, medical equipment, traffic control equipment, etc.), it is necessary to provide a fail-safe mechanism in the end equipment.
- Do not inject abnormal voltages into the output of this product. The injection of reverse voltage or over voltage exceeding nominal output voltage into the output terminal might cause damage to internal components.
- Never operate the product under over current or short-circuit conditions for more than 30 seconds, or outside its specified Input Voltage Range. Insulation failure, smoking, burning or other damage may occur.
- The outputs of this product may, under fault conditions, exceed SELV voltage limits. Therefore the outputs must be earthed in the end equipment to maintain SELV. If the outputs are not earthed, they must be considered hazardous and must not be made user accessible.
- This product has used Power Thermistor to protect the circuit from Inrush Current. Frequent repetition of input on/off might cause damage to internal components because of generating surge current.
- Breaking of internal fuse is considered internal failure. In such cases, please contact us.
- The information in this document is subject to change without prior notice. Please refer to the latest version of the data sheet, etc., for the most up-to date specifications of the product.
- No part of this document may be copied or reproduced in any form without prior written consent of TDK-Lambda.

Note: CE MARKING

CE marking, when applied to a product covered by this handbook, indicates compliance with the low voltage directive.

1. Model name identification method

CUS 250 LD-5 □

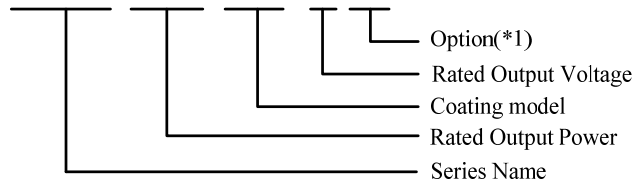

(*1)

Blank : -
/A : With cover type.

Model available:
CUS250LD-5
CUS250LD-5/A

2. Terminal Explanation

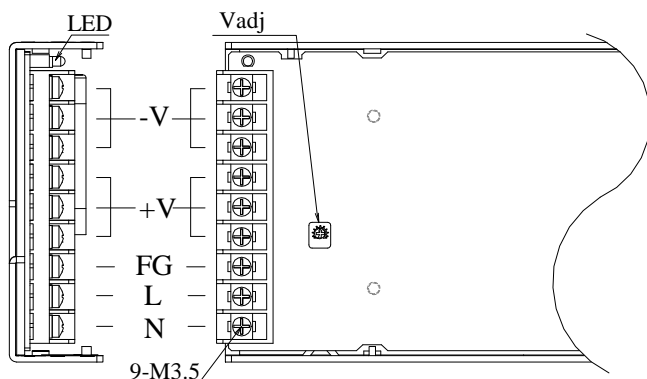

- ① L : AC Input terminal Live line (Fuse in line.)
- ② N : AC Input terminal Neutral line
- ③ FG: Frame Ground (Protective Bonding)
- ④ Vadj: Output voltage adjust trimmer. The output voltage rises when a trimmer is turned clockwise.
- ⑤ +V : + Output Terminal
- ⑥ -V : - Output Terminal
- ⑦ LED: Output monitoring indicator (Green color)

3. Terminal Connection Method

Pay attention to the input wiring. If it is connected to wrong terminal, the power supply will be damaged.

- Input must be off when making connections.
- Connect FG terminal of input connector to protective earth of the equipment.
- The output load line and input line shall be separated to improve noise sensitivity.
- Output current of each terminal pin of CUS250LD Series must be less than 20A.

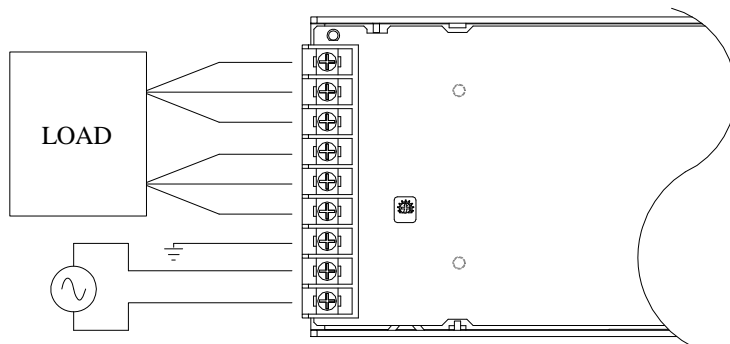

4. Explanation of Function and Precautions

4-1. Input Voltage Range

Input voltage range is single phase 85-265VAC (47-63Hz). Never operate the unit out of the specified input voltage range to avoid unit failure.

For cases where conformance to various safety requirement, input voltage range will be 100-240VAC (50-60Hz).

4-2. Output Voltage Range

Output voltage is set at rated value at shipment. Vadj trimmer (VR51) can adjust the output voltage within the range. Output voltage range is within $\pm 10\%$ of nominal output voltage. Turn the trimmer clockwise, the output voltage will be increased. Take note when the output voltage is increased excessively, over voltage protection (OVP) function may trigger and voltage will be shut down. Furthermore, when increasing the output voltage reduce the output current so as not to exceed the maximum output power.

4-3. Inrush Current

This series equipped Power Thermistor to limit the inrush current. Higher inrush current will flow at higher ambient temperature or re-input condition. Please select input switch and fuse carefully with the high temperature and re-input the power condition. The Inrush Current value is under cold start at 25°C in the specification.

4-4. Over Voltage Protection (OVP)

The OVP function (PSU shut down method, manual reset type) is provided. Please refer to its specification for OVP operating range. When OVP trigger, the output will be shut down. To reset OVP, remove the input of power supply for few minutes, and then re-input. In addition, the setting value of OVP is fixed and not adjustable. Pay attention not to apply higher voltage externally to the output terminal to avoid unit failure. In case of inductive load, put protective diode in series to the output power line.

4-5. Over Current Protection (OCP)

CUS250LD Series: Hiccup mode with automatic recovery.

OCP function operates when the output current exceeds 105% of maximum DC output current of specification. The output will be automatically recovered when the overload condition is canceled. Never operate the unit under over current or shorted conditions for more than 30seconds, which may lead damage or failure. OCP setting is fixed and not to be adjusted externally.

4-6. Output Ripple and Noise

Ripple and noise are measured at 20MHz by using a 12'' twisted pair terminated with a 0.1uF & 47uF capacitor. When load cables are longer, ripple will becomes larger. In this case, electrolytic capacitor, film capacitor, etc. might be necessary to use across the load terminal. The output ripple cannot be measured accurately if the probe ground lead of oscilloscope is too long. For start up at low ambient temperature, output ripple noise might not meet specification. However, output ripple noise specification can be met after few seconds.

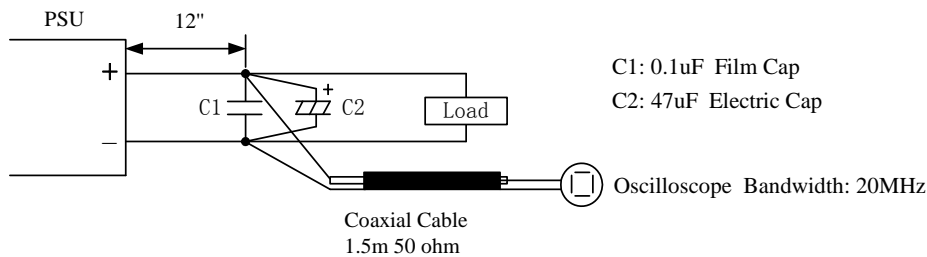

4-7. Series Operation

For series operation, either method (A) or (B) is possible.

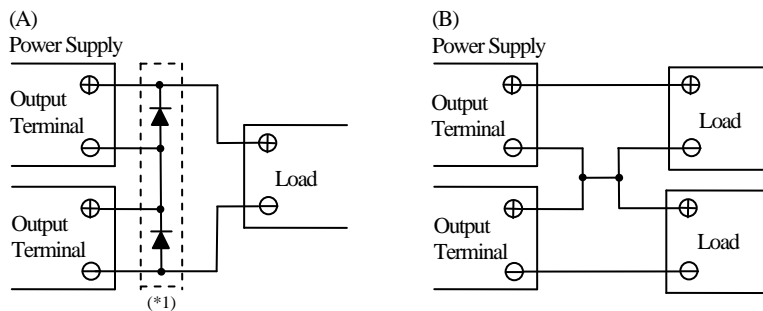

(*1)Please select a bypass diode with maximum forward current rating more than output load current. And maximum reverse voltage must withstand each power supply output voltage.

4-8. Parallel Operation

For parallel operation, method (B) is possible.

(A) To increase the output current is not possible.

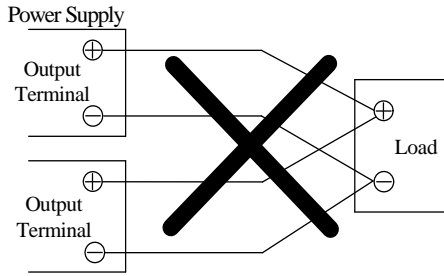

(B) To use as Back-up Power Supply

1. Adjust the output voltage of each power supply to be the same.
2. Set power supply output voltage higher by the forward voltage drop (V_f) of diode.

Use within the specification for output voltage and output power.

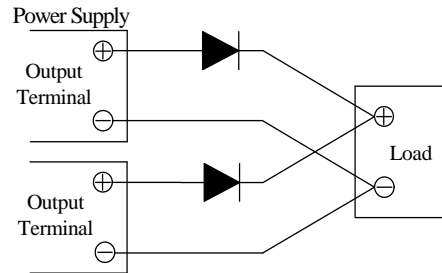

4-9. Isolation Test

Isolation resistance between Output – FG is more than 100M Ω at 500VDC. For safety operation, voltage setting of DC isolation tester must be done before the test. Ensure that the unit is fully discharged after the test.

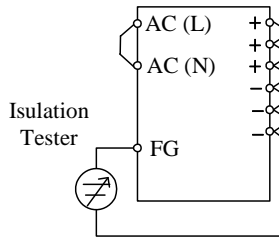

4-10. Withstand Voltage

This series is designed to withstand 3.0kVAC between input and output, 2.0kVAC between input and FG and 500VAC between output and FG each for 1 minute. When testing withstands voltage, set current limit of the withstand voltage test equipment to 20mA (output – FG: 100mA). The applied voltage must be gradually increased from zero to the testing value and then gradually decreased for shut down. When timer is used, the power supply may be damaged by high impulse voltage at timer switch on and off. Connect input and output as follows.

Input - Output (Dashedline): 3.0kVAC 1min (20mA)

Input - FG (Solidline): 2.0kVAC 1min (20mA)

Output - FG: 500VAC 1min (100mA)

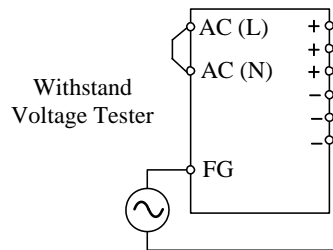
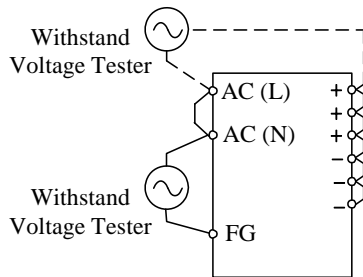

5. Mounting Directions

5-1. Output Derating according to the Mounting Directions.

Recommended standard mounting method is (A,C). Method (B,D,E) are also possible. Refer to the output derating below. Load(%) of derating curve indicates output power.

MOUNTING A	MOUNTING B	MOUNTING C	MOUNTING D	MOUNTING E	INHIBIT
Standard Mounting		Standard Mounting			

5-2. Output Derating vs. Ambient temperature

Make sure that the specified temperature range is maintained.

CONVECTION COOLING

Output derating for all models except CUS250LD :

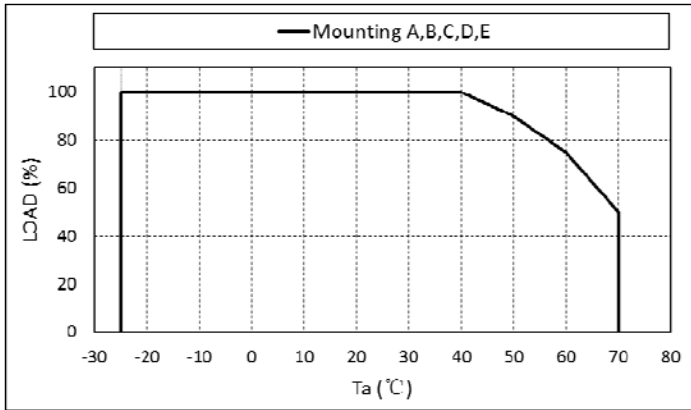

Ta (°C)	Mounting (A),(B),(C),(D),(E)
	Load (%)
-25 ~ 40	100
50	90
60	75
70	50

Output derating for CUS250LD/A :

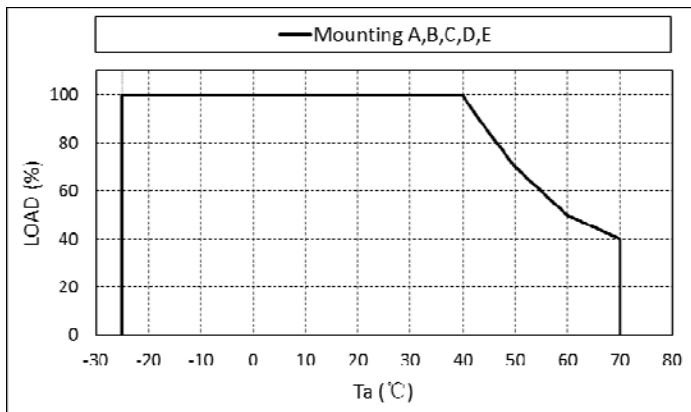

Ta (°C)	Mounting (A),(B),(C),(D),(E)
	Load (%)
-25 ~ 40	100
43	90
50	70
60	50
70	40

5-3. Output Derating vs. Input Voltage

Output derating is required when the PSU operate below 115VAC input. Refer to table below for details.

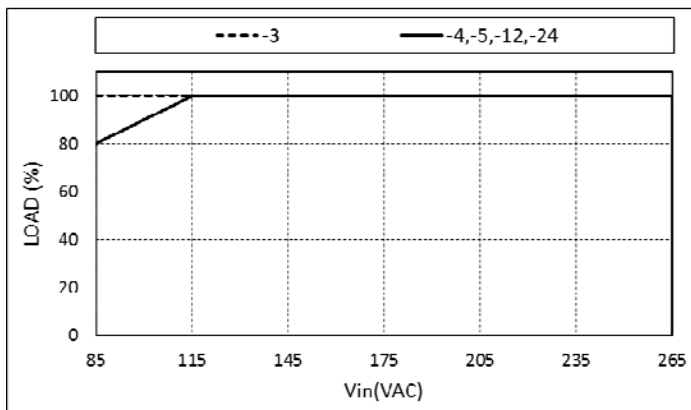

Input Voltage	Load (%)	
	-3	-4, -5, -12, -24
85VAC	100	80
115 ~ 265VAC	100	100

5-4. Mounting Method

- (1) The maximum allowable penetration for screw into chassis is 6mm.
- (2) Recommended torque for mounting screw: M3.5 screw, 0.74N·m (7.5kgf · cm).
- (3) Metal plate with minimum 1.5mm thickness is recommended as mounting plate.

- (4) Keep minimum 4mm space from the surface to component side and rear side for safety requirement.

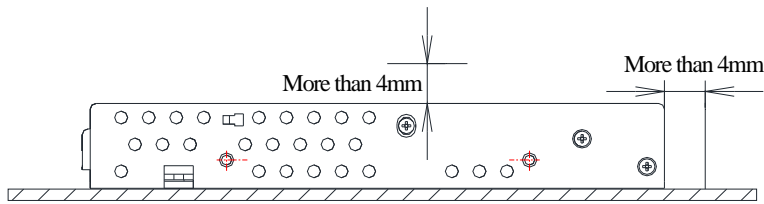

- (5) Keep enough space in the power supply surroundings and the upper area of components for convection cooling. As a reference for reliable thermal design, keep the temperature of Heat Sink lower than 100 °C at Test Point below.
- (6) Rear mounting from bottom side with 4-M3.5 screws is recommended to comply the vibration spec.

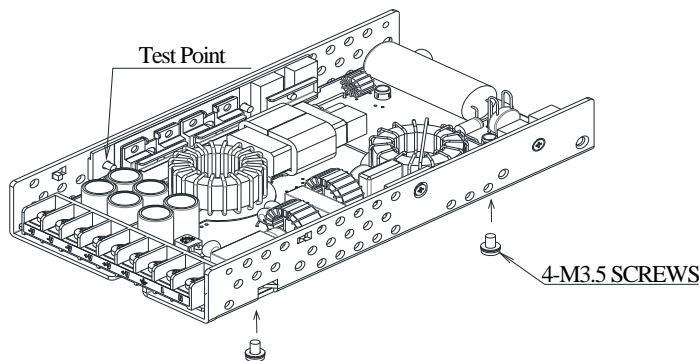

6. Wiring Method

- (1) The output and input cables shall be separated each other and twisted individually to improve noise sensitivity.
- (2) Use all cables as thick and short as possible to made lower impedance.
- (3) Noise can be reduced by attaching a capacitor to the load terminals.
- (4) For safety and EMI considerations, connect between FG terminal of input connector and Protective Earth terminal of equipment firmly.
- (5) Recommended torque for the terminal: M3.5 screw, 0.74N·m (7.5kgf · cm).

7. External Fuse Rating

Refer to the following fuse rating when selecting the external fuses that are to be used on input line. Surge current flows when line turns on. Have to use slow-blow or time-lag type fuse, not fast-blow fuse. Fuse rating is considered by in-rush current value at line turn-on. Do not select the fuse according to input current (RMS.) values under the actual load condition.

CUS250LD Series: 6.3A

8. Before concluding that the unit is at fault

- (1) Check if the rated input voltage is connected.
- (2) Check if the wiring of input and output is correct.
- (3) Check if the wire thickness is enough.
- (4) Check if the output current and output wattage dose not over specification.
- (5) Check if the output voltage control (Vadj) is properly adjusted. OVP might be triggered and output is shut down.
- (6) Audible noise can be heard when input voltage waveform is not sinusoidal wave.
- (7) Audible noise can be heard during Dynamic-Load operation.

9. Altitude

The clearance in power supply can meet 3000m altitude of IEC60950-1 and IEC60664-1.