

Cooleta™ iEH Series DC/DC Power Modules
 48V Input, 10.8V / 28A /300W Output
 IBC Eighth Brick



The Cooleta™ power module series provides exceptionally high useable power in an industry standard IBC eighth brick format. With up to 95% efficiency and a maximum power rating of 300W, the Cooleta series of converters is ideally suited for tight space, power-hungry, intermediate bus converter applications in demanding thermal environments. This rugged building block is designed to serve as the core of your high reliability power conversion system. The optional droop load current sharing capability allows multiple modules to be connected in parallel. The monotonic start-up into a pre-bias output capability with the synchronous rectification enhances versatility.

Standard Features:

- **RoHS Compliant**
- Standard IBC eighth brick with 5 pins
- Nominal size: 2.300" × 0.900" × 0.500"
(58.42mm × 22.86mm × 12.70mm)
- Up to 28A of output current
- **Tight output voltage regulation (flat line)**
- Output power – up to 300W
- Power density: 290W / in³
- High efficiency – up to 95%
- Typical efficiency at 28A (300W): 94%
- Monotonic start-up into a pre-biased output
- Digital adaptive control
- Single board design with high usable power
280W at 55°C, 200LFM (with base-plate)
192W at 85°C, 200LFM (with base-plate)
- Input to output isolation – 2,250Vdc tested
- Negative remote on/off logic
- Constant switching frequency
- Auto-recovery protection for input UVP
- Auto-recovery protection for input OVP
- Auto-recovery over-current protection
- Auto-recovery over-temperature protection
- Latched output over-voltage protection

- **IEC 60950-1 (2nd edition) AM1**
- **EN 60950-1/A12**
- EMI: CISPR 22 A or B with external filter
- Multiple patents
- ISO Certified manufacturing facilities

Optional Features:

- Positive remote on/off logic
- Latched over-current protection
- Latched over-temperature protection
- Auto-recovery OVP
- Base-plate (or heat plate)
- Droop load share

This page intentionally left blank

Data Sheet: Cooleta™ iEH Series –Single Output Eighth Brick

Mechanical Specification:

Dimensions are in mm [in]. Unless otherwise specified tolerances are: $x.x \pm 0.5$ [0.02], $x.xx$ and $x.xxx \pm 0.25$ [0.010].

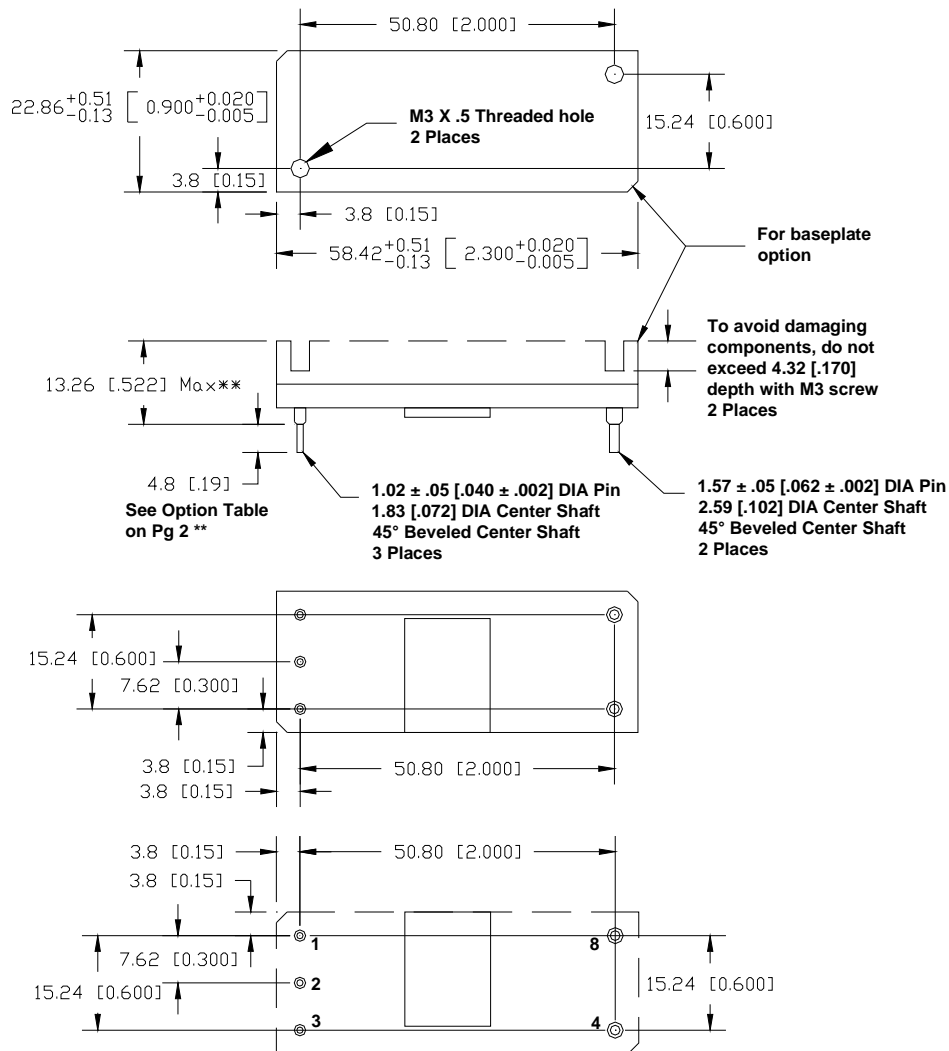

Recommended hole pattern (top view)

Pin Assignment:

PIN	FUNCTION	PIN	FUNCTION
1	Vin(+)	4	Vo(-)
2	On/Off	5	None
3	Vin(-)	6	None
		7	None
		8	Vo(+)

Pin base material is copper with gold plating. The maximum module weight with base plate is 50g.

** Module height and pin length are dependent on PCB hole size. Specified maximum module height and standard pin length as measured from customer PCB are based on $\varnothing.064$ " and $\varnothing.090$ " hole sizes for $\varnothing.040$ " and $\varnothing.062$ " pins respectively. Module sits on pins with 45° beveled center shaft. Pin lengths and module height will shift .001" for every .002" change in PCB hole diameter.

Data Sheet: Cooleta™ iEH Series –Single Output Eighth Brick

Absolute Maximum Ratings:

Stress in excess of Absolute Maximum Ratings may cause permanent damage to the device.

Characteristic	Min	Max	Unit	Notes & Conditions
Continuous Input Voltage	-0.5	80	Vdc	
Transient Input Voltage	---	100	Vdc	100mS max.
Isolation Voltage Safety Rating:				Basic Insulation
Input to Output	---	2250	Vdc	100% factory Hipot tested
Input to Base-plate	1500	---	Vdc	
Storage Temperature	-55	125	°C	
Operating Temperature Range (Tc)	-40	124	°C	Measured at the location specified in the thermal measurement figure. Maximum temperature varies with model number, output current, and module orientation – see curve in thermal performance section of the data sheet.

Input Characteristics:

Unless otherwise specified, specifications apply over all Rated Input Voltage, Resistive Load, and Temperature conditions.

Characteristic	Min	Typ	Max	Unit	Notes & Conditions	
Operating Input Voltage	36	48	75	Vdc		
Maximum Input Current	iEH48028A108V		---	9.0	A	Vin = 0 to Vin,max, Io=Io,max, Vo=Vo,nom
Input Low Turn-on Voltage	---	34.5	---	Vdc		
Input Low Turn-off Voltage	---	32.5	---	Vdc		
Input Low Hysteresis	---	2.0	---	Vdc		
Input High Turn-off Voltage	---	80.9	---	Vdc		
Input High Turn-on Voltage	---	76.2	---	Vdc		
Startup Delay Time from application of input voltage	---	12	---	mS	Vo = 0 to 0.1*Vo,nom; on/off =on, Io=Io,max, Tc=25°C	
Startup Delay Time from on/off	---	12	---	mS	Vo = 0 to 0.1*Vo,nom; Vin = Vi,nom, Io=Io,max, Tc=25°C	
Output Voltage Rise Time	---	29	---	mS	Io=Io,max, Tc=25°C, Vo=0.1 to 0.9*Vo,nom	
Inrush Transient	---	---	0.06	A²s	Exclude external input capacitors	
Input Reflected Ripple	---	18	---	mApp	See input/output ripple and noise measurements figure; BW = 20 MHz	
Input Ripple Rejection	---	---	---	dB	@120Hz	

* Engineering Estimate

Caution: The power modules are not internally fused. An external input line fast acting fuse with a maximum value of **15A** is required; see the Safety Considerations section of the data sheet.

Data Sheet: Cooleta™ iEH Series –Single Output Eighth Brick

Electrical Data:

iEH48028A108V-xx0 through -xx9: 10.8V, 28A, 300W Output

Characteristic	Min	Typ	Max	Unit	Notes & Conditions
Output Voltage Initial Setpoint	10.65	10.75	10.85	Vdc	Vin=Vin,nom; Io=5A; Tc = 25°C
Output Voltage Range	10.48	10.75	11.02	Vdc	Over all operating input voltage, load, and temperature conditions until end of life
Efficiency at 100% Load **	---	94	---	%	Vin=Vin,nom; Io=Io,max; Tc = 25°C
Line Regulation	---	25	50*	mV	Vin=Vin,min to Vin,max, Io=50% load, Tc=25°C
Load Regulation	---	60	100*	mV/A	Io=Io,min to Io,max, Vin=Vin,nom, Tc =25°C
Temperature Regulation	---	30	100*	mV	Tc=Tc,min to Tc,max, Vin and Io fixed
Load Share Accuracy (only option code)	-10	---	10	%	50% to 100% of total paralleling system maximum load current, Tc = 25°C
Output Voltage Droop Rate (option code)	---	36***	---	mV/A	When applicable. Vin=Vin,min to Vin,max, Tc=25°C
Output Current	0	---	28	A	At Io < 30% of Io,max, the step load transient performance may degrade slightly
Output Current Limiting Threshold	---	36	---	A	Vo = 0.9*Vo,nom, Tc<Tc,max
Short Circuit Current	---	2	---	A	Vo = 0.25V, Tc = 25C (Hiccup mode)
Output Ripple and Noise Voltage	---	84	150*	mVpp	Vin=48V, Io ≥ Io,min, Tc=25°C. Measured across one 0.1uF, one 1.0 uF, and one 47uF ceramic capacitors, and one 440uF OSCON or POSCAP capacitor located 2 inches away – see input/output ripple measurement figure; BW = 20MHz
	---	21.9	---	mVrms	
Output Voltage Adjustment Range	---	---	---	%Vo,nom	N/A
Output Voltage Sense Range	---	---	---	%Vo,nom	N/A
Dynamic Response:					di/dt = 0.1A/uS, Vin=Vin,nom; load step from 50% to 75% of Io,max, Tc=25°C with at least one 1.0 uF, one 47uF ceramic capacitors, and one 440uF OSCON or POSCAP capacitor across the output terminals
Recovery Time to 10% of Peak Deviation	---	700	---	μS	Note: Excluding the voltage droop
Transient Voltage	---	280	---	mV	
Output Voltage Overshoot during startup	0	0	---	mV	Vin=Vin,nom; Io=Io,max,Tc=25°C
Switching Frequency	---	140	---	kHz	Fixed
Output Over Voltage Protection	---	13.1	14.2*	V	Io=0.5A
External Load Capacitance	488	---	8,000 †	uF	Cext,min required for the 100% load dump. Minimum ESR > 2.5 mΩ
Isolation Capacitance	---	200	---	pF	At 120Hz
Isolation Resistance	15	---	---	MΩ	
Vref	---	---	---	V	N/A

* Engineering Estimate

** The module has no remote sense pins. The care must be taken when measures Vo to minimize the IR drop across the output pins

*** The droop rate can be adjusted per customer requirement.

† Contact TDK Lambda for applications that require additional capacitance or very low ESR

Electrical Characteristics: iEH48028A108V-xx0 through -xx9: 10.8V, 28A, 300W Output

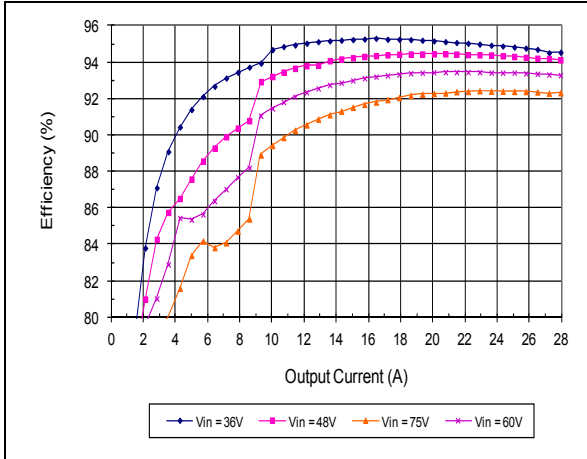

Efficiency at various lines and loads (test in socket, droop feature disabled)

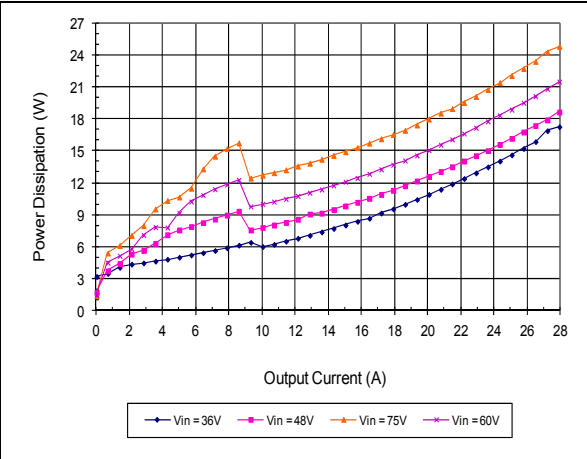

Power Dissipation at various lines and loads (test in socket, droop feature disabled)

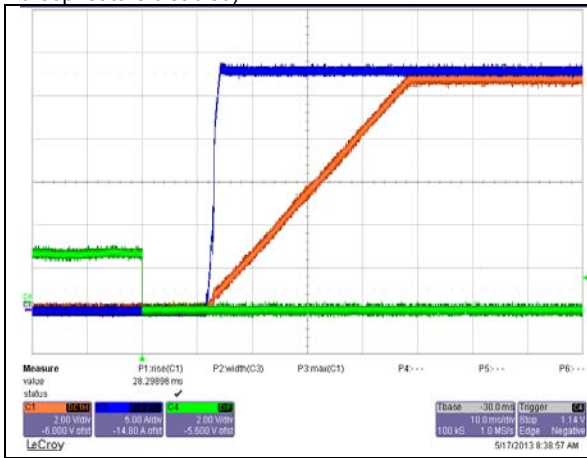

Start-up from on/off Switch at Vin,nom and Full Load. Ch. 1: Vo Ch. 3: Io Ch. 4: ON/OFF

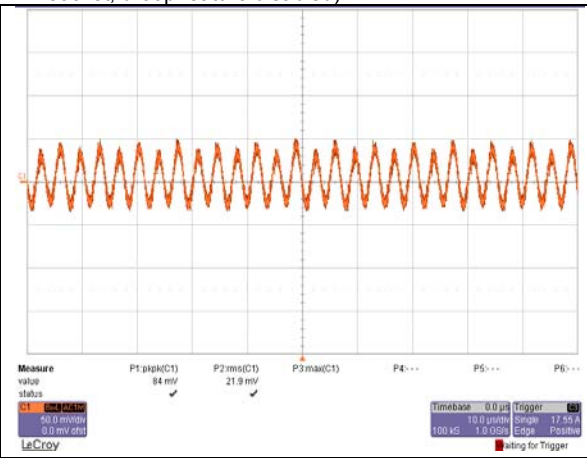

Typical Output Ripple at 48V Input and Full Load at Ta=25C Ch. 1: Vo

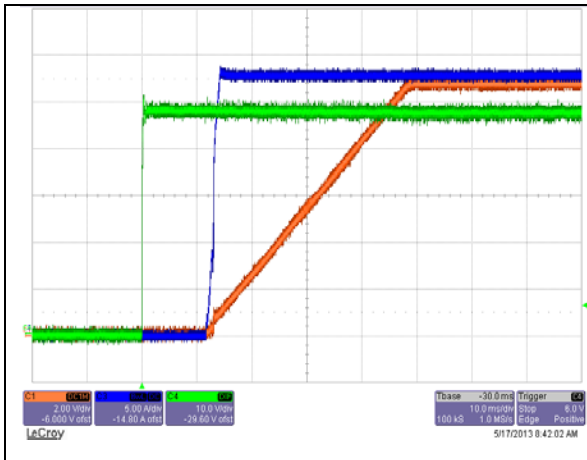

Start-up from Input Voltage Application at Full Load. Ch. 1: Vo Ch. 3: Io Ch. 4: Vin

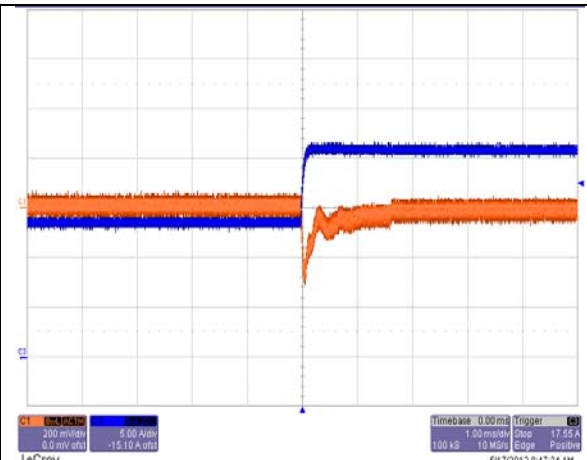

Load Transient Response. Load Step from 50% to 75% of Full Load with di/dt= 0.1A/uS. Ch. 1: Vo Ch. 3: Io

Electrical Characteristics: iEH48028A108V-xx0 through -xx9: 10.8V, 28A, 300W Output

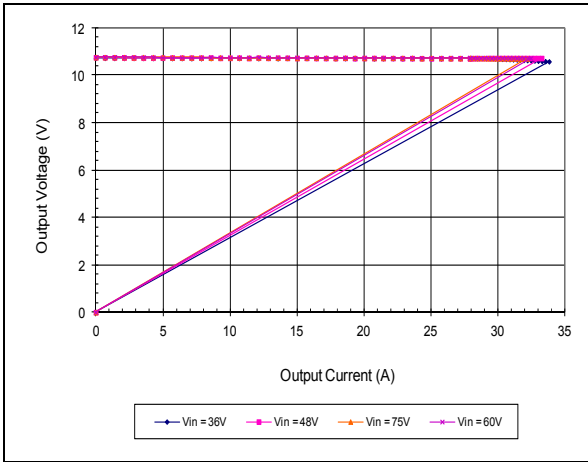

Output Current Limit Characteristics vs. Input Voltage (Droop Feature Disabled)

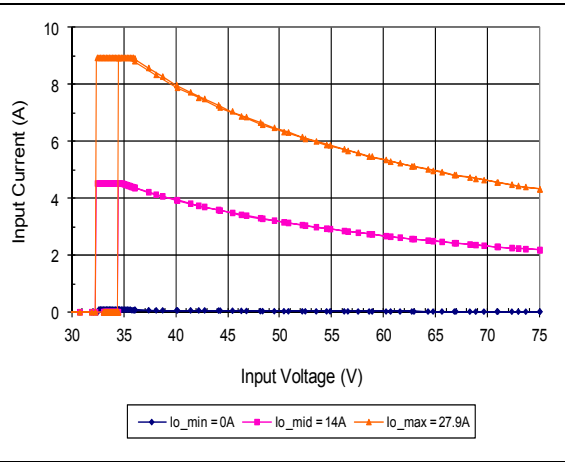

Typical Input Current vs. Input Voltage Characteristics

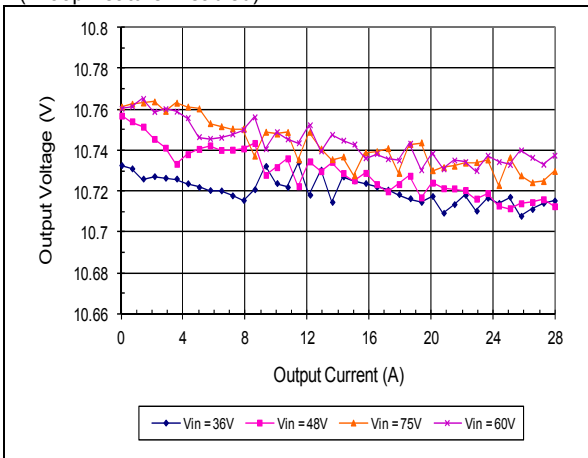

Typical Output Voltage vs. Load Current with Droop Feature Disabled

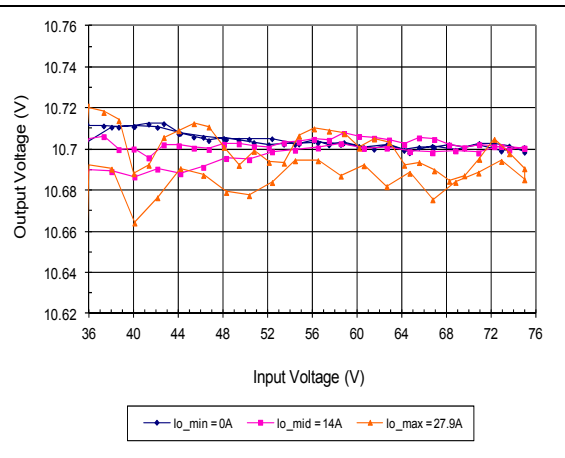

Typical Output Voltage vs. Input Voltage with Droop Feature Disabled

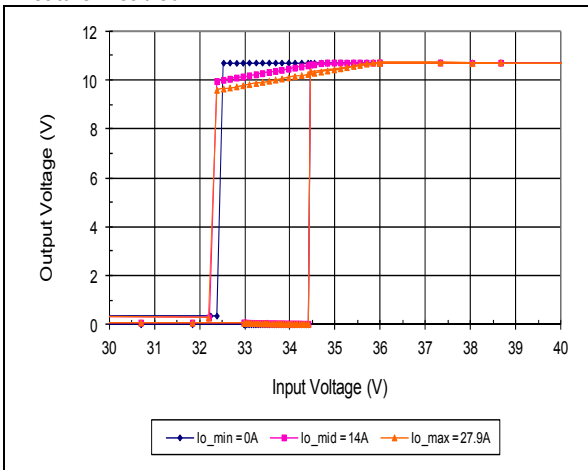

Typical Output Voltage vs. Low Voltage Input Turn-on and Turn-off

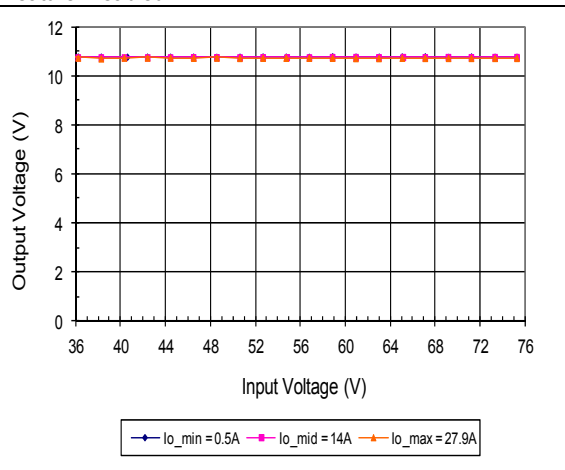

Typical Output Voltage vs. Input Voltage at Ta=55C

Thermal Performance: iEH48028A108V-xx0 through -xx9: 10.8V, 28A, 300W Output

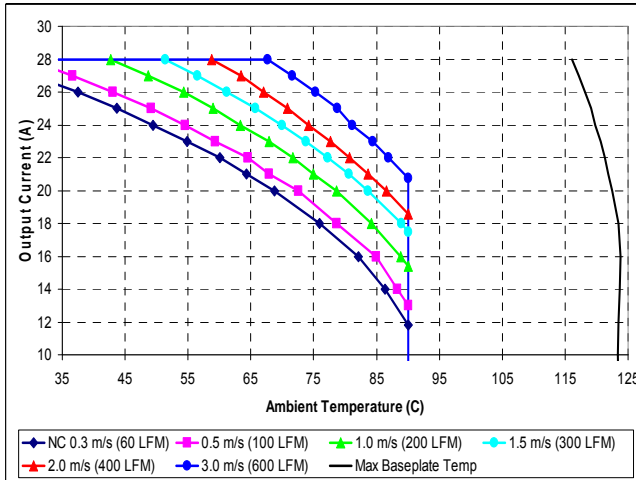

Maximum output current vs. ambient temperature at nominal input voltage **with base plate** for airflow rates natural convection (0.3m/s) to 3.0m/s with airflow from pin 3 to pin 1.

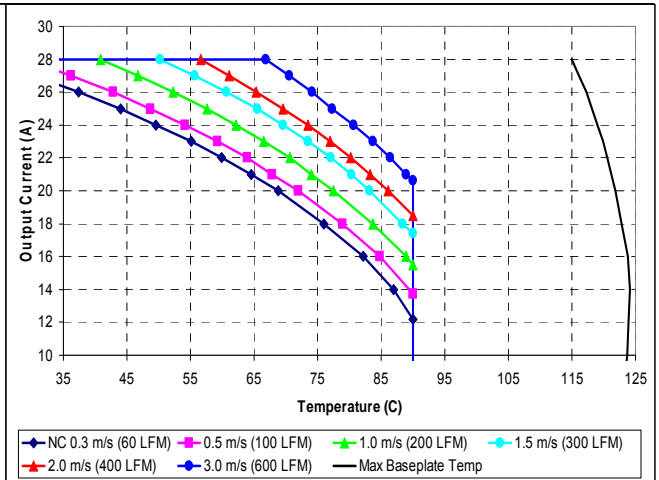

Maximum output current vs. ambient temperature at nominal input voltage **with base plate** for airflow rates natural convection (0.3m/s) to 3.0m/s with airflow from pin 1 to pin 3.

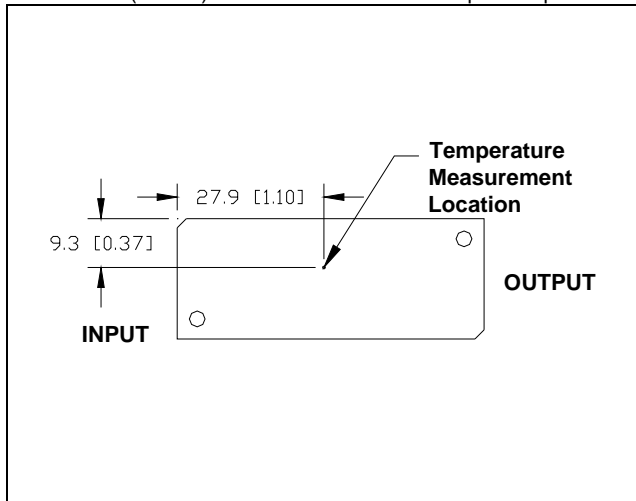

Thermal measurement location for base plate option – top view

The thermal curves provided are based upon measurements made in TDK Lambda's experimental test setup that is described in the Thermal Management section. Due to the large number of variables in system design, TDK Lambda recommends that the user verify the module's thermal performance in the end application. The critical component should be thermo- coupled and monitored, and should not exceed the temperature limit specified in the derating curve above. It is critical that the thermocouple be mounted in a manner that gives direct thermal contact otherwise significant measurement errors may result.

Thermal Management:

An important part of the overall system design process is thermal management; thermal design must be considered at all levels to ensure good reliability and lifetime of the final system. Superior thermal design and the ability to operate in severe application environments are key elements of a robust, reliable power module.

A finite amount of heat must be dissipated from the power module to the surrounding environment. This heat is transferred by the three modes of heat transfer: convection, conduction and radiation. While all three modes of heat transfer are present in every application, convection is the dominant mode of heat transfer in most applications. However, to ensure adequate cooling and proper operation, all three modes should be considered in a final system configuration.

The open frame design of the power module provides an air path to individual components. This air path improves convection cooling to the surrounding environment, which reduces areas of heat concentration and resulting hot spots.

Test Setup: The thermal performance data of the power module is based upon measurements obtained from a wind tunnel test with the setup shown in the wind tunnel figure. This thermal test setup replicates the typical thermal environments encountered in most modern electronic systems with distributed power architectures. The electronic equipment in networking, telecom, wireless, and advanced computer systems operates in similar environments and utilizes vertically mounted printed circuit boards (PCBs) or circuit cards in cabinet racks.

The power module is mounted on a 0.087 inch thick, 12-layer, 2oz/layer PCB and is vertically oriented within the wind tunnel. Power is routed on the internal layers of the PCB. The outer copper layers are thermally decoupled from the converter to better simulate the customer’s application. This also results in a more conservative derating.

The cross section of the airflow passage is rectangular with the spacing between the top of the module and a parallel facing PCB kept at a constant (0.5 in). The power module’s orientation with respect to the airflow direction can have a significant impact on the unit’s thermal performance.

Thermal Derating: For proper application of the power module in a given thermal environment, output current derating curves are provided as a design guideline in the

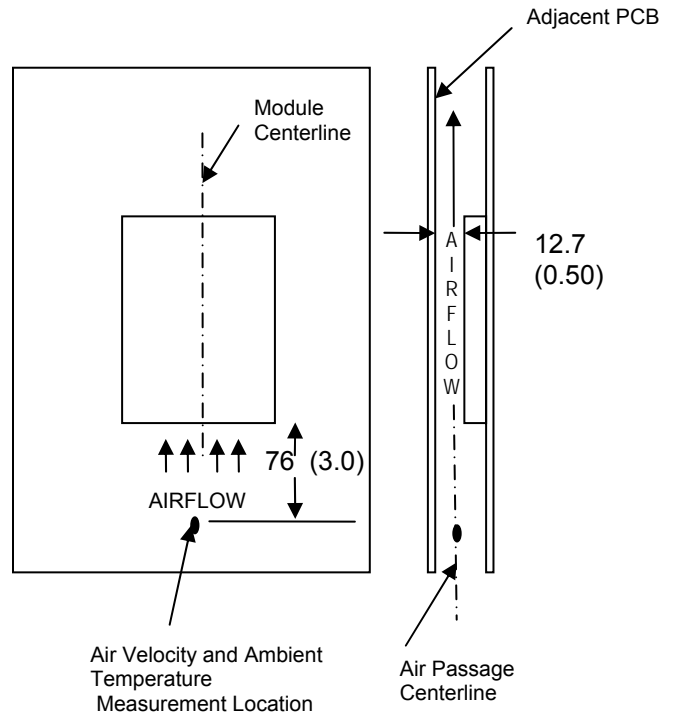

Wind Tunnel Test Setup Figure

Dimensions are in millimeters and (inches).

Thermal Performance section for the power module of interest. The module temperature should be measured in the final system configuration to ensure proper thermal management of the power module. For thermal performance verification, the module temperature should be measured at the component indicated in the thermal measurement location figure on the thermal

performance page for the power module of interest. In all conditions, the power module should be operated below the maximum operating temperature shown on the derating curve. For improved design margins and enhanced system reliability, the power module may be operated at temperatures below the maximum rated operating temperature.

Heat transfer by convection can be enhanced by increasing the airflow rate that the power module experiences. The maximum output current of the power module is a function of ambient temperature (T_{AMB}) and airflow rate as shown in the thermal performance figures on the thermal performance page for the power module of interest. The curves in the figures are shown for natural convection through 3 m/s (600 ft/min). The data for the natural convection condition has been collected at 0.3 m/s (60 ft/min) of airflow, which is the typical airflow generated by other heat dissipating components in many of the systems that these types of modules are used in. In the final system configurations, the airflow rate for the natural convection condition can vary due to temperature gradients from other heat dissipating components.

Heat sink Usage: For applications with demanding environmental requirements, such as higher ambient temperatures or higher power dissipation, the thermal performance of the power module can be improved by attaching a heat sink or cold plate. The iEH platform is designed with a base plate with two M3 X 0.5 through-threaded mounting fillings for attaching a heat sink or cold plate. The addition of a heat sink can reduce the airflow requirement; ensure consistent operation and extended reliability of the system. With improved thermal performance, more power can be delivered at a given environmental condition.

If a heat sink is used, a thermal interface pad is required between the power module and the heat sink to reduce the thermal impedance. The mounting screws should be installed using a torque-limiting driver set between 0.35-0.55 Nm (3-5 in-lbs).

The system designer must use an accurate estimate or actual measure of the internal airflow rate and temperature when doing the heat sink thermal analysis. For each application, a review of the heat sink fin orientation should be completed to verify proper fin alignment with airflow direction to maximize the heat sink effectiveness.

Operating Information:

Over-Current Protection: The power modules have current limit protection to protect the module during output overload and short circuit conditions. During overload conditions, the power modules may protect themselves by entering a hiccup current limit mode. In the first minute, the hiccup rate is about 1 second. After about 1 minute, the hiccup rate will change to 10 seconds interval until the fault is removed for over 30 seconds. Otherwise, the module will stay at 10 second hiccup rate. The modules will operate normally once the output current returns to the specified operating range. A latched over-current protection option is also available. Consult the TDK Lambda technical support for details.

Output Over-Voltage Protection: The power modules have a control circuit, independent of the main output voltage feedback control loop, that reduces the risk of over voltage appearing at the output of the power module during a fault condition. If there is a fault in the main regulation loop, the over voltage protection circuitry will latch the power module off once it detects the output voltage condition as specified on the Electrical Data page. To remove the module from the latched condition, either cycle the input power or toggle the remote ON/OFF pin providing that over-voltage conditions have been removed. The reset time of the ON/OFF pin should be 100ms or longer.

An optional non-latching OVP protection feature is also available. Consult the TDK Lambda technical support for details.

Thermal Protection: When the power modules exceed the maximum operating temperature, the modules will turn-off to safeguard the units against thermal damage. The module will auto restart as the unit is cooled below the over temperature threshold. A latched over-temperature protection option is also available. Consult the TDK Lambda technical support for details.

Remote On/Off: - The power modules have an internal remote on/off circuit. The user must supply an open-collector or compatible switch between the Vin(-) pin and the on/off pin. The maximum voltage generated by the power module at the on/off terminal is 13V. The maximum allowable leakage current of the switch is 50uA. The switch must be capable of maintaining a low signal Von/off < 0.8V while sinking 200uA.

The standard on/off logic is negative logic. The module will turn on if pin 2 is connected to pin 3, and it will be off if pin 2 is left open. If the negative logic feature is not being used, pin 2 should be shorted to pin 3.

An optional positive logic is available. The power module will turn on if pin 2 is left open and will be off if pin 2 is connected to pin 3. If the positive logic circuit is not being used, terminal 2 should be left open.

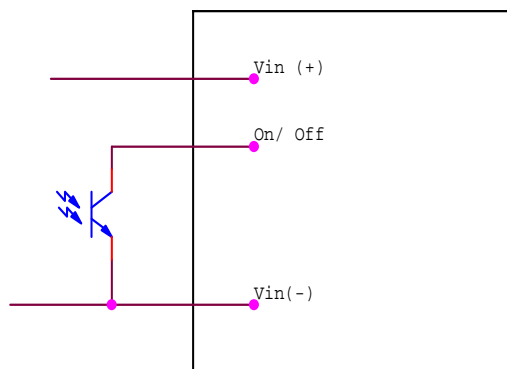

On/Off Circuit for positive or negative logic

Output Voltage Adjustment:

Not applicable for this product code.

Remote Sense:

Not applicable for this product code.

Data Sheet: Cooleta™ iEH Series –Single Output Eighth Brick

EMC Considerations: TDK Lambda power modules are designed for use in a wide variety of systems and applications. With the help of external EMI filters and careful layout, it is possible to meet CISPR 22 class A or B requirement. For assistance with designing for EMC compliance, please contact TDK Innoveta technical support.

Input Impedance: The source impedance of the power feeding the DC/DC converter module will interact with the DC/DC converter. To minimize the interaction, one or more 220uF/100V input capacitors should be present if the source inductance is greater than 4uH.

Reliability:

The power modules are designed using TDK Lambda's stringent design guidelines for component derating, product qualification, and design reviews. Early failures are screened out by both burn-in and an automated final test. The MTBF is calculated to be over 3M hours at nominal input, full load, and $T_a = 40^\circ\text{C}$ using the Telcordia TR-332 issue 6 method.

Improper handling or cleaning processes can adversely affect the appearance, testability, and reliability of the power modules. Contact TDK Lambda technical support for guidance regarding proper handling, cleaning, and soldering of TDK Lambda's power modules.

Quality:

TDK Lambda's product development process incorporates advanced quality planning tools such as FMEA and Cpk analysis to ensure designs are robust and reliable. All products are assembled at ISO certified assembly plants.

Safety Considerations:

For safety agency approval of the system in which the DC-DC power module is installed,

the power module must be installed in compliance with the creepage and clearance requirements of the safety agency. The isolation is basic insulation. For applications requiring basic insulation, care must be taken to maintain minimum creepage and clearance distances when routing traces near the power module.

As part of the production process, the power modules are hi-pot tested from primary and secondary at a test voltage of 2250Vdc.

To preserve maximum flexibility, the power modules are NOT internally fused. An external input line fast acting fuse with a maximum value of 15A is required by safety agencies. A lower value fuse can be selected based upon the maximum dc input current and inrush energy of the module.

When the supply to the DC-DC converter is less than 60Vdc, the power module meets all of the requirements for SELV. If the input voltage is a hazardous voltage that exceeds 60Vdc, the output can be considered SELV only if the following conditions are met:

- 1) The input source is isolated from the ac mains by reinforced insulation.
- 2) The input terminal pins are not accessible.
- 3) One pole of the input and one pole of the output are grounded or both are kept floating.
- 4) Single fault testing is performed on the end system to ensure that under a single fault, hazardous voltages do not appear at the module output.

Warranty:

TDK Lambda's comprehensive line of power solutions includes efficient, high-density DC-DC converters. TDK Lambda offers a three-year limited warranty. Complete warranty information is listed on our web site or is available upon request from TDK Lambda.

Input/Output Ripple and Noise Measurements:

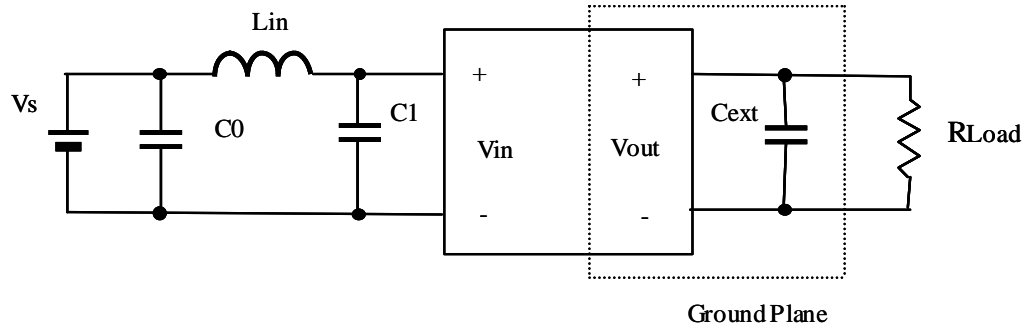

The input reflected ripple is measured with a current probe and oscilloscope. The ripple current is the current through a 12 μ H differential mode inductor, L_{in} , with $esr \leq 10\text{ m}\Omega$, feeding a capacitor, C_1 , $esr \leq 700\text{ m}\Omega @ 100\text{kHz}$, across the module input voltage pins. The capacitor C_1 across the input shall be at least one 220 μ F/100V capacitor along with two 1 μ F to 2.2 μ F/100V ceramic capacitors. Two 220 μ F/100V capacitors and two 2.2 μ F/100V ceramic capacitors are recommended. A 220 μ F/100V capacitor for C_0 is also recommended.

The output ripple measurement is made approximately 7 cm (2.75 in.) from the power module using an oscilloscope and BNC socket. The capacitor C_{ext} is located about 5 cm (2 in.) from the power module; its value varies from code to code and is found on the electrical data page for the power module of interest under the ripple & noise voltage specification in the Notes & Conditions column.

TDK Lambda Americas

3320 Matrix Drive, Suite 100
Richardson, Texas 75082

Phone (877) 498-0099 Toll Free

(214) 347-5869

Fax (214) 239-3102

DTC-support@us.tdk.com
<http://www.tdkinnoveta.com/>

Information furnished by TDK Lambda is believed to be accurate and reliable. However, TDK Lambda assumes no responsibility for its use, nor for any infringement of patents or other rights of third parties, which may result from its use. No license is granted by implication or otherwise under any patent or patent rights of TDK Lambda. TDK Lambda components are not designed to be used in applications, such as life support systems, wherein failure or malfunction could result in injury or death. All sales are subject to TDK Lambda's Terms and Conditions of Sale, which are available upon request. Specifications are subject to change